

# Montage

## Installation Manual

GALERIE select

*GALERIE select*



1.

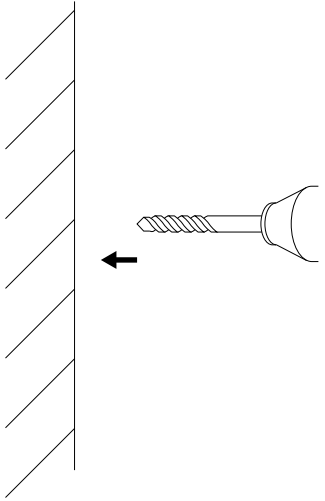

2.

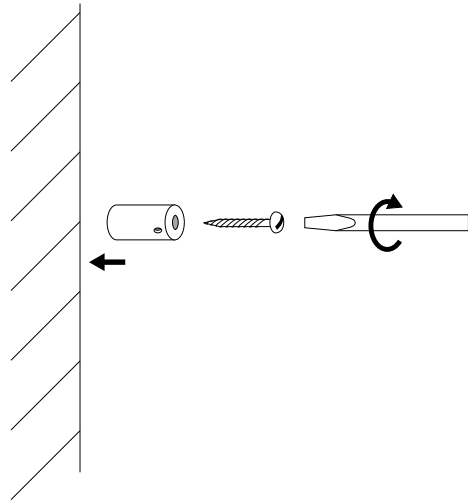

3.

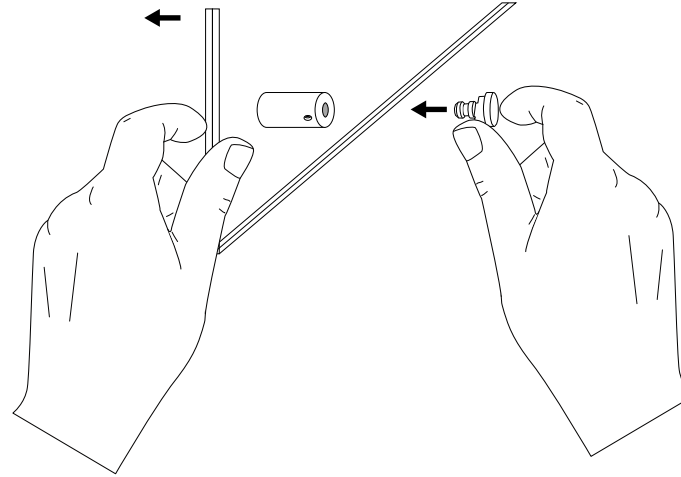

4.

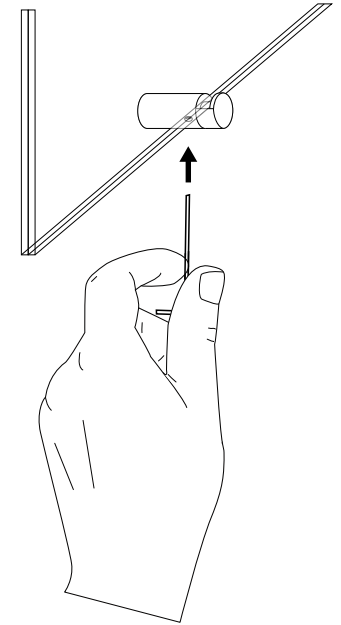

**Verpackungsinhalt:**

- 1x 2 ESG Scheiben + 2 oder 4 Abstandhalter je Set
- 1x Inbusschlüssel

**Content:**

- 1x 2 safety glass panel + 2 or 4 distance holders per set
- 1x allen key

**Benötigtes Werkzeug:**

- Bohrmaschine
- Schraubendreher

**Required Tools:**

- drill machine
- screwdriver